

DC Motors

BL4550-2435

Issue 03

Rotalink

Miniature Motors, Transmission and Control

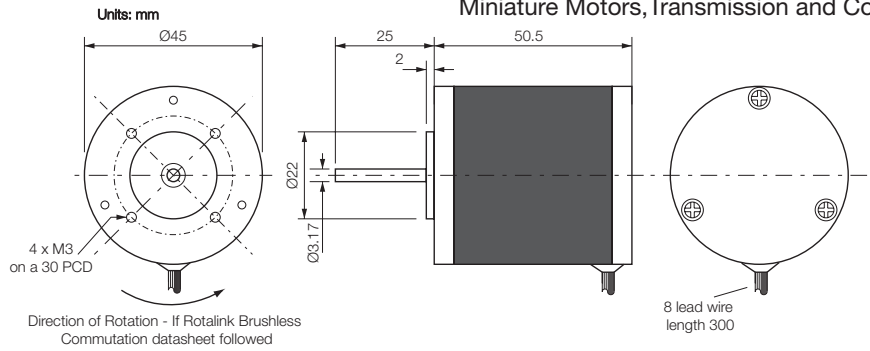

Model Number	Performance									
	Volts V	No Load		Maximum Efficiency				Stall		Max Power W
		Speed rpm	Current A	Speed rpm	Current A	Torque mNm	Output W	Torque mNm	Current A	
BL4550-2435	24	7056	0.64	5735	2.74	69.9	41.9	374.7	12.26	69.2

Performance characteristics and general specification are measured from sample motor.

Hall Effect Sensor Wire 26 AWG					Motor Phase Wire 22 AWG		
Yellow	Green	Blue	Red	Black	Yellow	Green	Blue
HA	HB	HC	+5	GND	M1	M2	M3

Characteristics

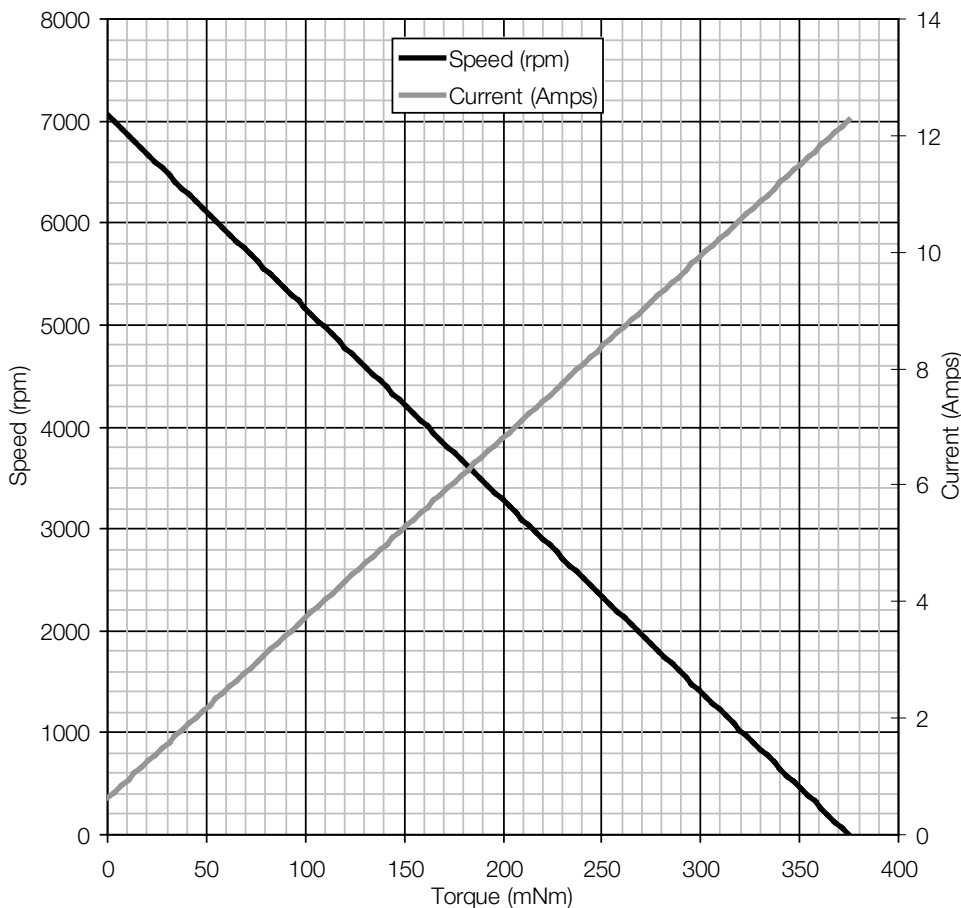

General Specification

Bearings	Ball Race
Rotation	Bi-directional
Number of poles	4
Operating voltage	24 V
Nominal resistance	2.3 Ω
Typical detent torque	17 mNm
Weight	320 g

Contact:

www.rotalink.com
 info@rotalink.com
 T: +44 (0)1460 72000
 F: +44 (0)1460 74278

Rotalink Limited
 Cropmead, Crewkerne
 Somerset TA18 7HQ, UK

www.rotalink.com