

DC Motors

D3650-3540

Issue 02

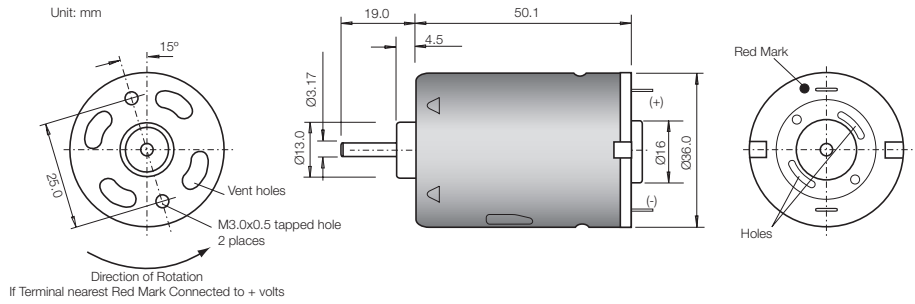

Model Number	Performance										
	Volts V	No Load		Maximum Efficiency					Stall		Max Power W
		Speed rpm	Current A	Speed rpm	Current A	Torque mNm	Output W	Efficiency %	Torque mNm	Current A	
D3650-3540	12	10550	0.60	8960	2.18	20.2	19.0	73%	132.2	12.64	35.6

Performance characteristics and general specification are measured from sample motor.

Characteristics

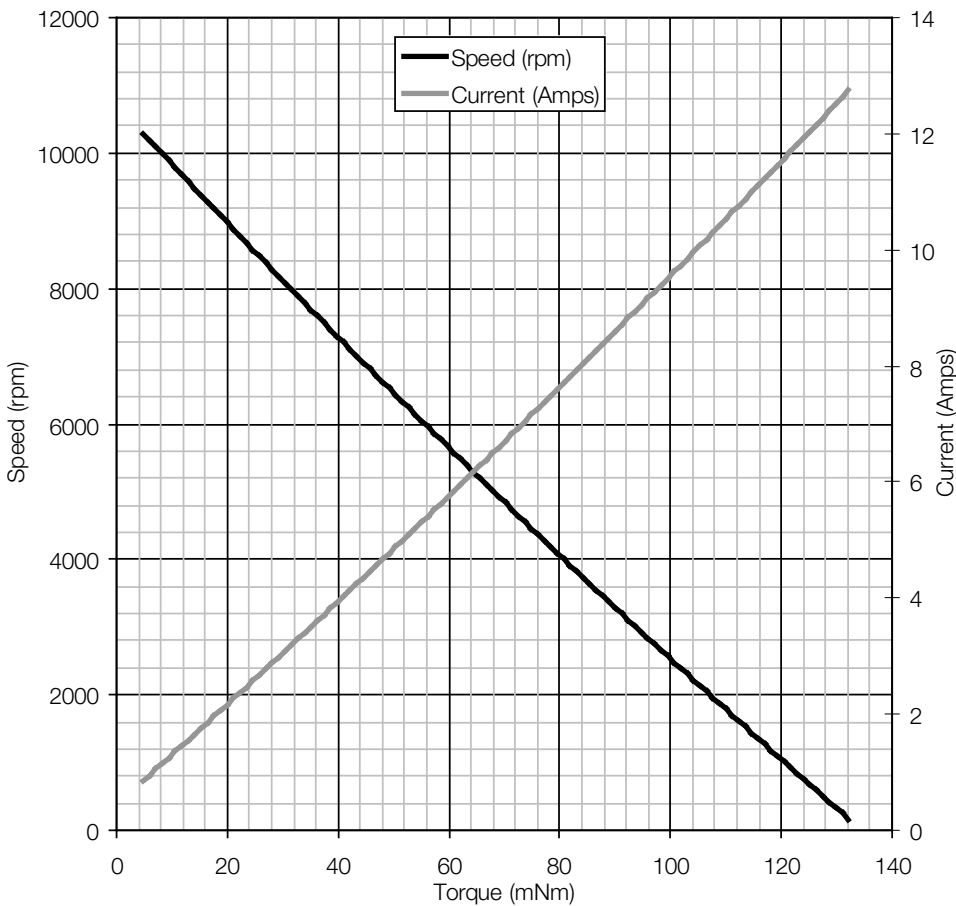

General Specification

Bearings	Sintered
Brushes	Carbon
Rotation	Bi-directional
Number of poles	5
Operating voltage	8 V to 16 V
Nominal resistance	2.3 Ω
Typical detent torque	6 mNm
Suppression	None
Weight	155 g

Contact:

www.rotalink.com
 info@rotalink.com
 T: +44 (0)1460 72000
 F: +44 (0)1460 74278

Rotalink Limited
 Cropmead, Crewkerne
 Somerset TA18 7HQ, UK

www.rotalink.com