

Permanent Magnet Stepping Motors

SU5526-048

Issue 04

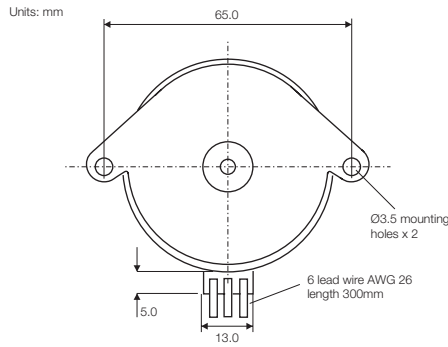

Rotalink

Miniature Motors, Transmission and Control

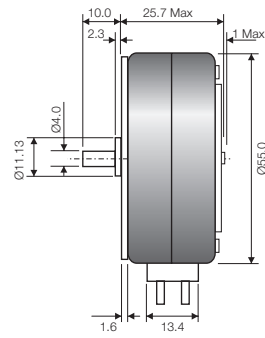

Model Number	Phase voltage (V)	Phase current (A)	Phase resistance (Ω)	Phase inductance (mH)	Winding
SU5526-048-020-12	12	0.600	20	17.0	Uni-polar

General Specification

Holding torque	200mNm
Step angle	7.5°
Rotor Inertia	3.7 kgm ² x10 ⁻⁶
Temperature rise	40°C
Ambient temp. range	-10°C to +50°C
Dielectric strength	500V AC 1sec
Weight	218g

Characteristics

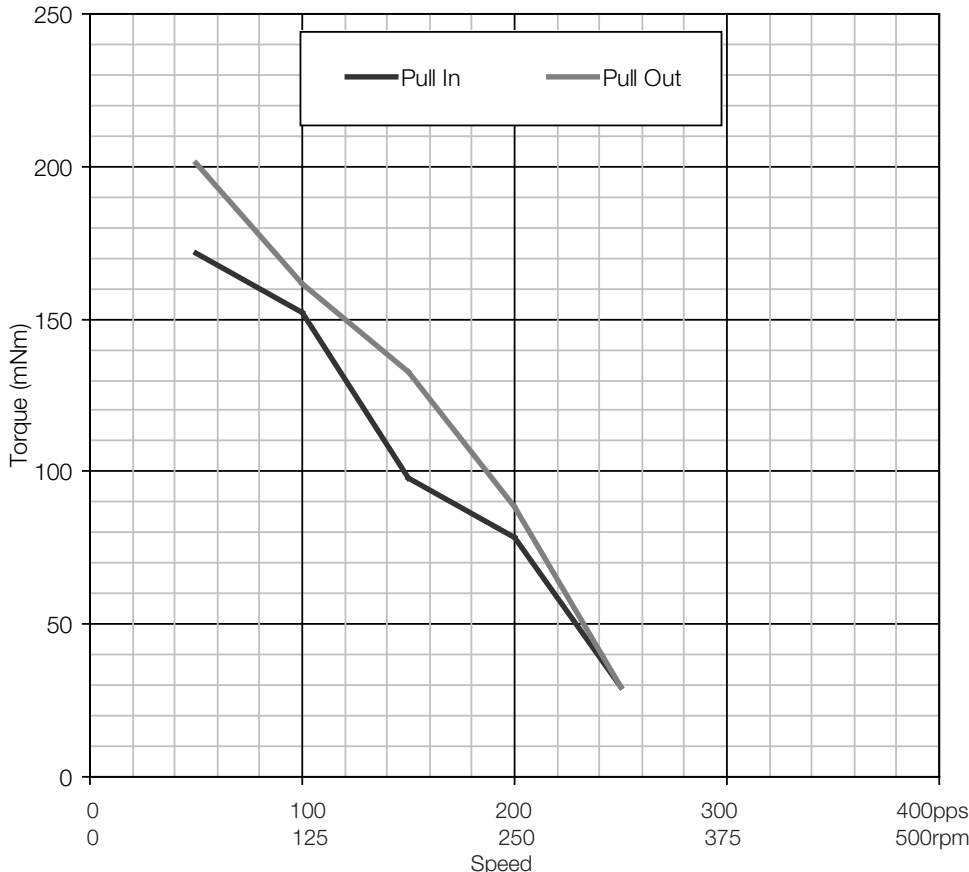

Drive: SM02 full step uni-polar drive @ nominal phase voltage & current
Load Inertia: 0.124x10⁻⁶ kgm²

Full step uni-polar sequence

CW dir.	Step 1	Step 2	Step 3	Step 4
Black	Off	On	On	Off
Brown	On	Off	Off	On
Orange	Off	Off	On	On
Yellow	On	On	Off	Off

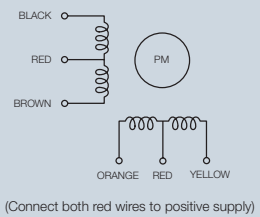

Contact:

www.rotalink.com
info@rotalink.com
 T: +44 (0)1460 72000
 F: +44 (0)1460 74278

Rotalink Limited
 Cropmead, Crewkerne
 Somerset TA18 7HQ, UK

www.rotalink.com